

VERTICAL STACK WATER SOURCE HEAT PUMP (VSHPW) CERTIFIED DRAWING

DWG. NO.
Submittal Template VSHPW
REV. - 01

PROJECT	DATE	BY	REVISIONS				
PURCHASER	P.O. #	QTY	DATE	BY	DESCRIPTION		
ARCHITECT	SHIPPING DATES						
ENGINEER							
HVAC CONTR.							
GEN. CONTR.							

DESIGNATION	MODEL NUMBER	QTY
TOTAL		

UNIT SPECIFICATIONS+

PERFORMANCE DATA

MODEL	8VSHPW09	8VSHPW12	8VSHPW15	8VSHPW18	8VSHPW24	8VSHPW30	8VSHPW36
COOLING CAPACITY*	9,500	13,200	13,700	17,600	22,700	27,800	36,500
COOLING EER	14.0	13.7	14.4	14.4	13.0	13.7	12.9
SENSIBLE CAPACITY	7,100	9,700	10,600	12,800	17,100	22,200	26,200
HEATING CAPACITY**	11,900	14,700	15,400	19,100	27,200	31,900	41,800
HEATING COP	4.4	4.2	4.5	4.4	4.1	4.4	3.8
TYPICAL CFM	420	500	540	630	770	1000	1080

TABLE 1

* BTUH @ 80.6°F DB, 66.2°F WB EAT; 86°F EWT @ 3 GPM/TON
 ** BTUH @ 68°F DB, 59°F WB EAT; 68°F EWT @ 3GPM/TON

GENERAL NOTES

- 1: PROVIDE UNITS WITH R410A GREEN REFRIGERANT
- 2: PROVIDE 1" WASHABLE FILTERS
- 3: PROVIDE OVERFLOW CONDENSATE SWITCH
- 4: PROVIDE STANDARD UNIT-MOUNTED DIGITAL CONTROL BOARD
- 5: PROVIDE PAINTED FRONT ACCESS PANEL.
- 6: PROVIDE INTEGRAL TRAPPED CONDENSATE LINE RUN OUT

PHYSICAL DATA

MODEL	8VSHPW09	8VSHPW12	8VSHPW15	8VSHPW18	8VSHPW24	8VSHPW30	8VSHPW36
COMPRESSOR TYPE (1 EA)	ROTARY						
REFRIGERANT	R410A						
REFRIGERANT FACTORY CHARGE (oz)	28.2	32.5	32.5	38.8	40.9	52.9	67.0
FAN MOTOR (W)	35	35	35	150	150	200	200
BLOWER WHEEL SIZE (DIAMETERXWIDTH) (IN)	7X7	7X7	7X7	7X7	7X7	8X8	8X8
HOSES (IN)	1/2	1/2	1/2	3/4	3/4	3/4	3/4
AIR COIL DIMENSION (IN)	20X11.4	20X11.4	20X11.4	26X12.2	26X12.2	28X17.13	29.5X17.13
STANDARD FILTER-1/2"	29.5X13.9	29.5X13.9	29.5X13.9	31.1X15.9	31.1X15.9	31.6X19.8	31.6X19.8
AC CHASSIS WEIGHT (LB)	100	102	102	137	138	160	165
CABINET WEIGHT (LB)	156	156	156	183	183	260	264

TABLE 2

OPTIONAL

- 1: STAINLESS STEEL HOSE KITS
- 2: MOTORIZED TWO-WAY CONTROL VALVE
- 3: BALL VALVES
- 4: DOUBLE DEFLECTION SUPPLY GRILLES
- 5: UNIT-MOUNTED FLOW CONTROL VALVE

CUSTOM NOTES

- 1:

For overall unit dimensions please refer to drawing APA-9088

TYPICAL WATER SIDE DATA

MODEL	8VSHPW09	8VSHPW12	8VSHPW15	8VSHPW18	8VSHPW24	8VSHPW30	8VSHPW36
FLOW RATE (GPM)	1.5	2.0	2.3	3.0	4.0	5.0	6.0
WATER CONNECTION SIZE (IN)	1/2	1/2	1/2	3/4	3/4	3/4	3/4
CONDENSATE CONNECTION SIZE (IN)	3/4" ID						

TABLE 3

VERTICAL STACK WATER SOURCE HEAT PUMP (VSHPW) CERTIFIED DRAWING

DWG. NO.
Submittal Template VSHPW
REV. - 01

PROJECT	DATE	BY	REVISIONS			
PURCHASER	P.O. #	QTY	DATE	BY	DESCRIPTION	
ARCHITECT	SHIPPING DATES					
ENGINEER						
HVAC CONTR.						
GEN. CONTR.						

UNIT SPECIFICATIONS+

ELECTRICAL DATA

TABLE 4

MODEL	VOLTAGE/HZ-PHASE	COMPRESSOR RLA	COMPRESSOR LRA	FAN MOTOR FLA	MCA	MOP	FUSE SIZE
8VSHPW09	208-230/60-1	4.05	20	0.7	5.8	10	15
8VSHPW12	208-230/60-1	5.4	27	0.7	7.5	12	15
8VSHPW15	208/230/60-1	5.4	27	2.0	8.0	13	15
8VSHPW18	208/230/60-1	7.35	42	2.0	11.2	19	15
8VSHPW24	208-230/60-1	9.9	55.4	1.85	14.4	24	20
8VSHPW30	208/230/60-1	11.6	60.2	1.85	16.5	28	25
8VSHPW36	208-230/60-1	15.45	75.6	3.98	23.3	39	35

AIR FLOW CORRECTION TABLE

TABLE 5

	% OF RATED AIR FLOW	70%	75%	80%	85%	90%	95%	100%	105%
COOLING FACTORS	TOTAL CAPACITY	0.92	0.93	0.95	0.96	0.97	0.99	1.00	1.02
	SENSIBLE CAPACITY	0.80	0.83	0.87	0.90	0.93	0.97	1.00	1.04
	POWER	0.97	0.97	0.98	0.99	0.99	1.00	1.00	1.01
	HEAT REJECTION	0.94	0.95	0.96	0.97	0.98	0.99	1.00	1.01
HEATING FACTORS	HEATING CAPACITY	0.94	0.95	0.96	0.97	0.98	0.99	1.00	1.01
	POWER	1.08	1.06	1.05	1.04	1.02	1.01	1.00	0.99
	HEAT EXTRACTION	0.93	0.95	0.96	0.97	0.98	0.99	1.00	1.01

AIR TEMPERATURE CORRECTION TABLE

TABLE 6

HEATING								
EAT DB (°F)	45	50	55	60	65	70	75	80
HEATING CAPACITY FACTOR	1.11	1.09	1.06	1.04	1.02	1.00	0.98	0.95
POWER FACTOR	0.77	0.81	0.86	0.91	0.95	1.00	1.05	1.10
HEAT EXTRACTION FACTOR	1.18	1.14	1.11	1.07	1.04	1.00	0.96	0.92

TABLE 7

COOLING						
EAT WB (°F)		60	65	67	70	75
TOTAL CAPACITY FACTOR		0.85	0.96	1.00	1.06	1.17
SENSIBLE CAPACITY FACTOR EAT DB	70	0.85	0.62	0.52	-	-
	75	1.09	0.86	0.76	0.62	-
	80	1.33	1.09	1.00	0.86	0.63
	85	*	1.33	1.23	1.09	0.85
	90	*	*	1.48	1.34	1.10
	95	*	*	*	1.56	1.32
POWER FACTOR		1.00	1.00	1.00	1.00	1.01
HEAT REJECTION FACTOR		0.90	0.97	1.00	1.05	1.12

DB - DRY BULB AIR TEMPERATURE
WB - WET BULB AIR TEMPERATURE
EAT - ENTERING AIR TEMPERATURE
ALL TEMPERATURES ARE IN °F
* = SENSIBLE CAPACITY EQUALS TOTAL CAPACITY

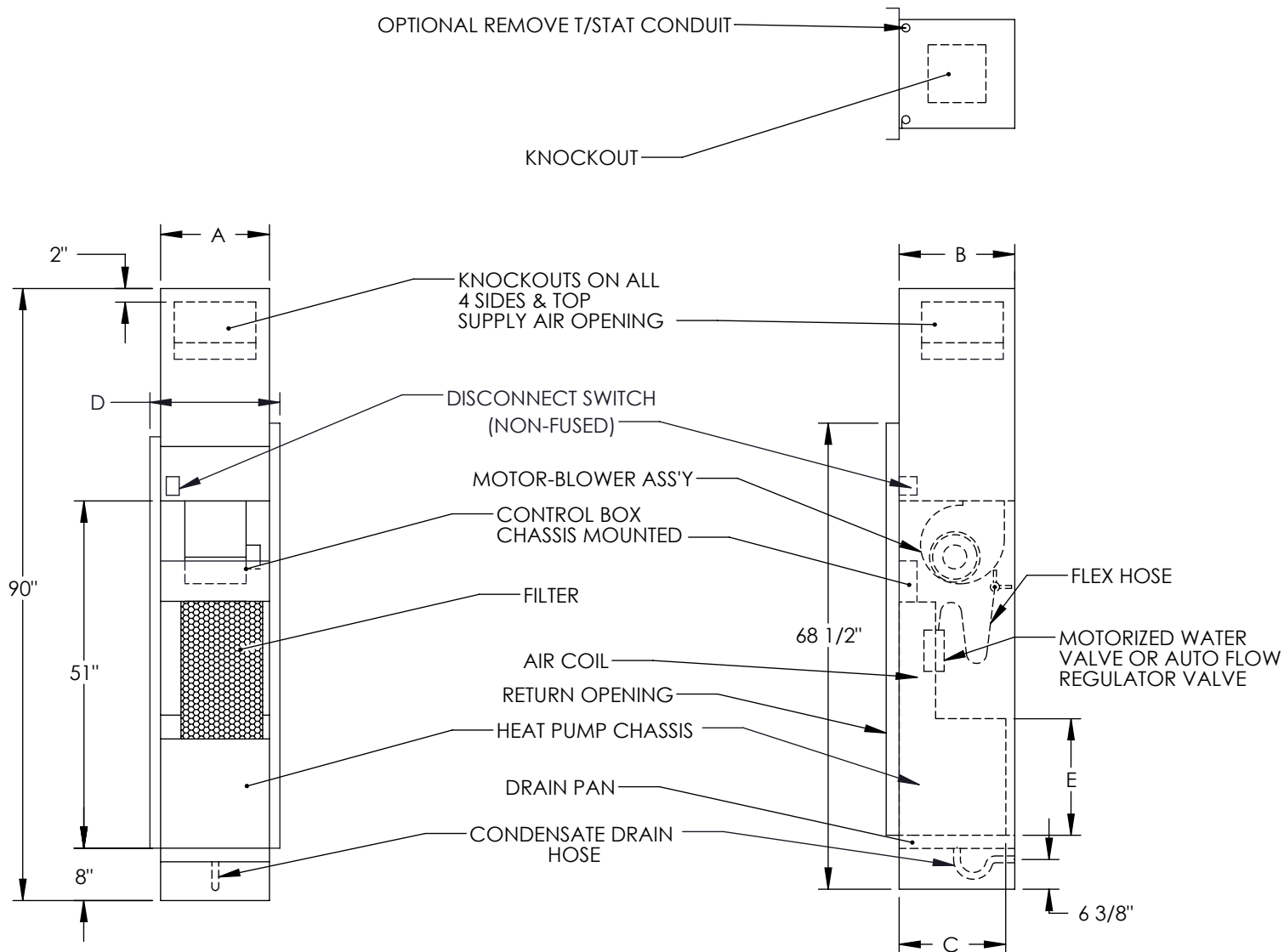

PER ICE-AIR'S ONGOING DEVELOPMENT PROGRAM, SPECIFICATIONS ARE SUBJECT TO CHANGE WITHOUT NOTICE

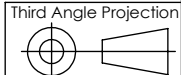
MATERIAL:	ICE-AIR LLC. 80 HARTFORD AVENUE MOUNT VERNON, NY 10553		
WEIGHT (LBS):			
FINISH:	TITLE:	VERTICAL STACK WATER SOURCE HEAT PUMP (VSHPW)	
UNLESS OTHERWISE SPECIFIED: DIMENSIONS ARE IN INCHES TOLERANCES: FRACTIONAL $\pm 1/32$ ANGULAR: MACH \pm ° BEND $\pm 1^\circ$ TWO PLACE DECIMAL $\pm .03$ THREE PLACE DECIMAL $\pm .015$	MODEL BY:	DATE:	DWG. NO. Template VSHPW
	DRAWING BY:	DATE:	
	SIZE A	SCALE: NONE DO NOT SCALE DRAWING	SHEET 3 OF 6
			REV

PROPRIETARY AND CONFIDENTIAL
THIS DRAWING IS PROPERTY OF
ICE-AIR, LLC. IT MAY NOT BE
REPRODUCED, DUPLICATED OR
OTHERWISE COPIED WITHOUT
PRIOR WRITTEN AUTHORIZATION.

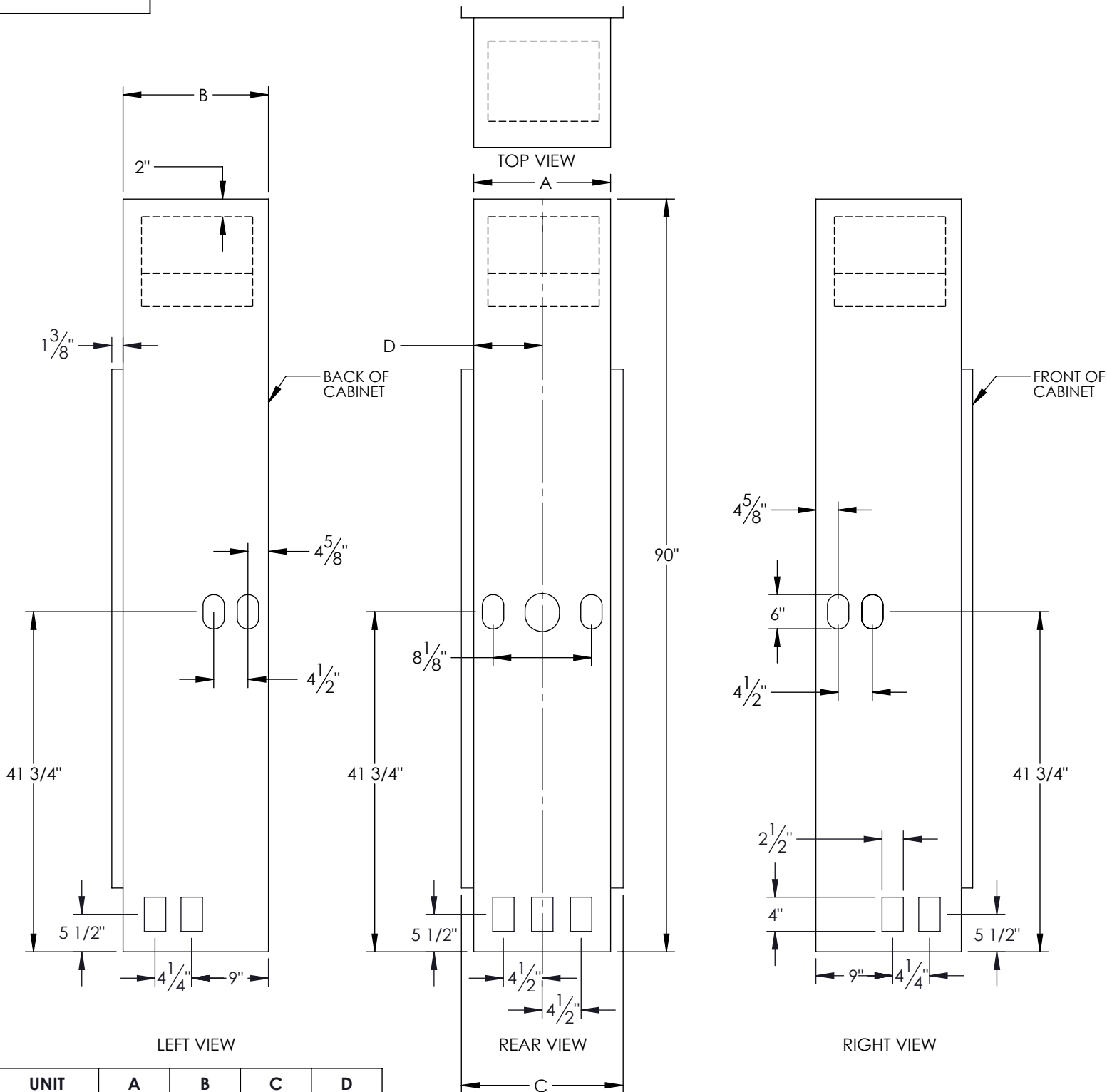

UNIT	A	B	C	D
VSHPW-09/12/15K	16"	17"	19"	8"
VSHPW-18/20/24K	18"	20"	21"	9"
VSHPW-30/36K	22"	24"	25"	11"

PER ICE-AIR'S ONGOING DEVELOPMENT PROGRAM, SPECIFICATIONS ARE SUBJECT TO CHANGE WITHOUT NOTICE

MATERIAL:	ICE-AIR LLC. 80 HARTFORD AVENUE MOUNT VERNON, NY 10553		
WEIGHT (LBS):			
FINISH:	TITLE: DIMENSIONAL DRAWING		
UNLESS OTHERWISE SPECIFIED: DIMENSIONS ARE IN INCHES TOLERANCES: FRACTIONAL: ± 1/32 ANGULAR: MACH ± ° BEND ± 1° TWO PLACE DECIMAL ± .03 THREE PLACE DECIMAL ± .015	MODEL BY:	DATE:	DWG. NO. Template VSHPW
	DRAWING BY:	DATE:	
	SIZE A	SCALE: NONE DO NOT SCALE DRAWING	REV
	SHEET 4 OF 6		

PROPRIETARY AND CONFIDENTIAL
This drawing is the intellectual property of Ice Air LLC and consists of confidential data belonging solely to Ice Air LLC. The sharing of this data with you does not constitute a license to share this data with any third party, which is strictly prohibited without Ice Air's prior written consent.

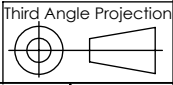

SINGLE SUPPLY

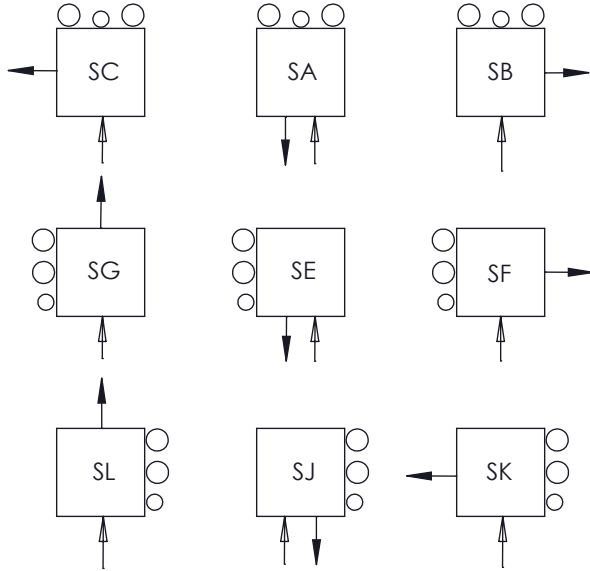

DOUBLE SUPPLY

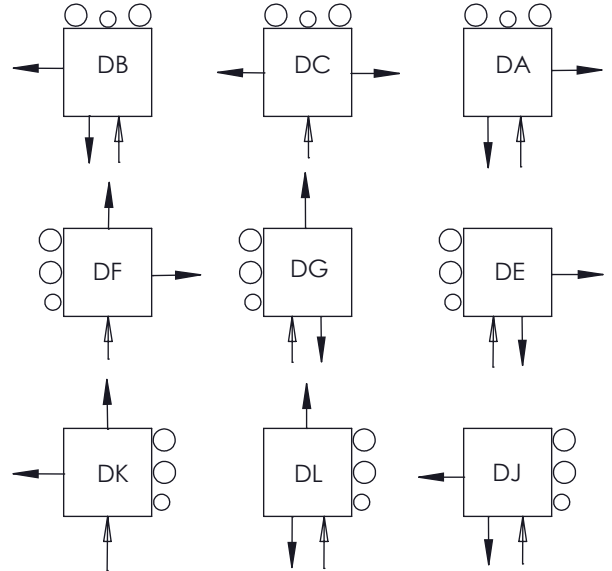

TRIPLE SUPPLY

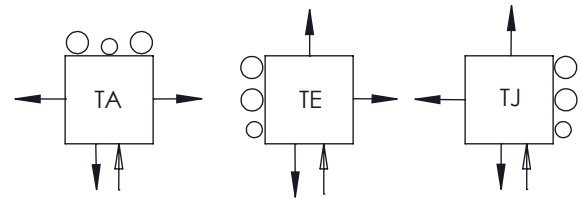

← RETURN AIR FROM ROOM
 ← SUPPLY AIR TO ROOM

Notes:

1. The Riser Compartment is defined as being the rear of each unit. Supply air grilles and return/access panel can be any side except rear.
2. Return air location also denotes the control location and service access.
3. Single discharge openings are not recommended for sizes 30-36. Triple discharge openings are not recommended for sizes 09, 12.

NOTES:

- 1) DIMENSIONS ARE IN INCHES
- 2) ALL DIMENSIONS ARE +/- 1/4"
- 3) DISCHARGE GRILLES ARE SHIPPED LOOSE FOR FIELD INSTALLATION
- 4) CONSTRUCTION IS ROLL FORMED ALUMINUM FRAME BLADES
- 5) STANDARD FINISH IS "POWDER COATED" AND WILL BE THE SAME COLOR AS THE RETURN GRILLE
- 6) MOUNTING HARDWARE INCLUDED



LEFT

CABINET

RIGHT

FRONT

PER ICE-AIR'S ONGOING DEVELOPMENT PROGRAM, SPECIFICATIONS ARE SUBJECT TO CHANGE WITHOUT NOTICE

MATERIAL:	<p align="center">ICE-AIR LLC. 80 HARTFORD AVENUE MOUNT VERNON, NY 10553</p>		
WEIGHT (LBS):			
FINISH:	TITLE: DIMENSIONAL DRAWING		
UNLESS OTHERWISE SPECIFIED: DIMENSIONS ARE IN INCHES TOLERANCES: FRACTIONAL ± 1/32 ANGULAR: MACH ± ° BEND ± 1° TWO PLACE DECIMAL ± .03 THREE PLACE DECIMAL ± .015	MODEL BY:	DATE:	DWG. NO. Submittal Template VSHPW
	DRAWING BY:	DATE:	
	SIZE A	SCALE: NONE DO NOT SCALE DRAWING	SHEET 5 OF 6
			REV 01

PROPRIETARY AND CONFIDENTIAL

This drawing is the intellectual property of Ice Air, LLC and consists of confidential data belonging solely to Ice Air, LLC. The sharing of this data with you does not constitute a license to share this data with any third party, which is strictly prohibited without Ice Air's prior written consent.

Third Angle Projection

UNIT	SPEED	SINGLE DISCHARGE	DOUBLE DISCHARGE	TRIPLE DISCHARGE	TOP DISCHARGE
		12" x 12"	12" x 8"	12" x 8"	12" x 12"
8VSHPW09	HIGH	X	X	NR	X
	LOW	X	X	NR	X
8VSHPW12	HIGH	X	X	NR	X
	LOW	X	X	NR	X
8VSHPW15	HIGH	X	X	X	X
	LOW	X	X	X	X
UNIT	SPEED	SINGLE DISCHARGE	DOUBLE DISCHARGE	TRIPLE DISCHARGE	TOP DISCHARGE
		14" x 14"	14" x 8"	14" x 8"	14" x 14"
8VSHPW18	HIGH	X	X	X	X
	LOW	X	X	X	X
8VSHPW24	HIGH	X	X	X	X
	LOW	X	X	X	X
UNIT	SPEED	SINGLE DISCHARGE	DOUBLE DISCHARGE	TRIPLE DISCHARGE	TOP DISCHARGE
		18" x 14"	18" x 10"	18" x 10"	18" x 14"
8VSHPW30	HIGH	NR	X	X	X
	LOW	NR	X	X	X
8VSHPW36	HIGH	NR	X	X	X
	LOW	NR	X	X	X

SIDE KNOCKOUTS

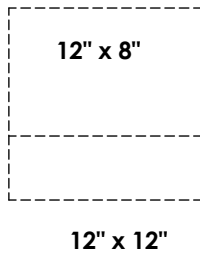

12" x 8"

12" x 12"

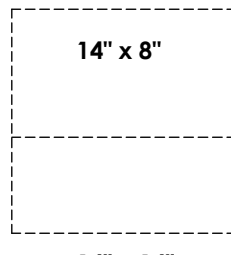

14" x 8"

14" x 14"

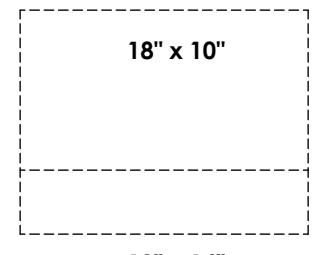

18" x 10"

18" x 14"

TOP KNOCKOUTS

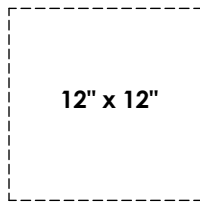

12" x 12"

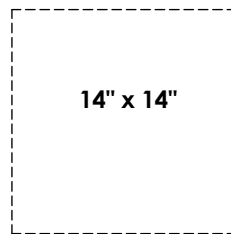

14" x 14"

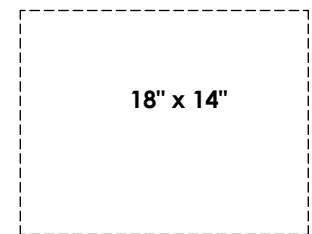

18" x 14"

GRILLE SIZES

12" x 8"

12" x 12"

14" x 8"

14" x 14"

18" x 10"

18" x 14"

MATERIAL:	<p align="center">ICE-AIR LLC. 80 HARTFORD AVENUE MOUNT VERNON, NY 10553</p>		
WEIGHT (LBS):			
FINISH:	TITLE:	GRILLE CHART	
UNLESS OTHERWISE SPECIFIED: DIMENSIONS ARE IN INCHES TOLERANCES: FRACTIONAL ± 1/32 ANGULAR: MACH ± ° BEND ± 1° TWO PLACE DECIMAL ± .03 THREE PLACE DECIMAL ± .015	MODEL BY:	DATE:	DWG. NO. Submittal Template VSHPW
	DRAWING BY:	DATE:	
	SIZE A	SCALE: NONE DO NOT SCALE DRAWING	SHEET 6 OF 6

PROPRIETARY AND CONFIDENTIAL

This drawing is the intellectual property of Ice Air, LLC and consists of confidential data belonging solely to Ice Air, LLC. The sharing of this data with you does not constitute a license to share this data with any third party, which is strictly prohibited without Ice Air's prior written consent.

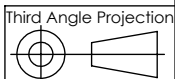

VERTICAL STACK, MODEL "8VSHW" SIZE 09-36
WATER SOURCE HEAT PUMP SPECIFICATIONS

October, 5th, 2016

General:

Furnish and install Ice Air Hybrid Water Cooled A/C, as indicated on the plans with capacities and characteristics as listed in the schedule and the specifications that follow.

Vertical Stack Hybrid Water Cooled A/C:

Units shall operate in range 60° to 104°F entering water. All equipment listed in this section must be rated in accordance with American Refrigeration Institute / International Standards Organization (ARI / ISO) and Environmental Testing Laboratories for United States and Canada (ETL-US-C). The units shall have ETL-US-C labels. All cabinets and chassis shall be factory tested under normal operating and water flow rates.

Basic Construction:

The cabinet panels shall be fabricated from heavy gauge galvanized steel. Cabinet shall be constructed so that it is self-supporting, and can be installed before chassis arrival. Top, base, and exterior panels are to be 16 gauge. The fan deck is 12 gauge. Cabinet shall have a top panel and a bottom panel for structural rigidity of the cabinet; no "open" top or "open" bottom designs allowed.

The cabinet base shall contain a secondary drain pan with a pressure differential drain trap connected to the condensate riser pipe, and guide rails to support and align the slide-in refrigeration chassis. Drain pan(s) shall be easily accessible for cleaning. All interior surfaces shall be lined with 1/2 inch (12.7mm) thick, dual density 1-3/4 lb/ft³ (28 kg/m³) acoustic type fiberglass insulation. All fiberglass shall be coated to prevent the introduction of glass fibers into the air stream.

Standard cabinet panel insulation must meet NFPA 90A requirements, air erosion and mold growth limits of UL-181, stringent fungal resistance test per ASTM-C1071 and ASTM G21, and shall meet zero level bacteria growth per ASTM G22.

Cabinet arrangements shall allow placement of riser piping on any of the three sides of the cabinet not used for the chassis access. All Cabinets will have front discharge opening along with knockouts on 3 sides and the top. For air noise attenuation purposes, the discharge air from fan shall discharge into an insulated plenum that also contains insulated air baffles at all cabinet supply air openings. The cabinet shall contain an easily removable motor/blower assembly.

Fan and Motor Assembly:

The cabinet shall contain a removable motor/blower assembly. Units shall have a direct-drive centrifugal fan. The fan motor shall be 2-speed cooling/2 speed heating, permanently lubricated, ECM type with thermal overload protection. The fan motor shall be isolated from the fan housing by a torsionally flexible motor mounting system with rubber type grommets to inhibit vibration-induced high noise levels associated with “hard wire belly band” motor mounting.

Airflow/External static pressure rating of the unit shall be based on a wet coil and clean filter.

Fan deck is designed to slide out from the front, after the chassis is removed.

Chassis:

The chassis, which incorporates the air coil, drain pan, compressor, coaxial condenser coil and hydronic heating coil, shall be an easily installed, slide-in type for quick jobsite installation and future servicing purposes. The slide-in chassis shall have an insulated panel separating the fan compartment from the compressor compartment. Compressors are not in the air stream. The chassis base shall be fabricated from heavy gauge galvanized steel formed to match the slide-in rails of the cabinet. All electrical connections between the chassis and cabinet shall be made via locking Molex type connectors. Units shall have a factory installed 1-inch (25.4mm) thick filter bracket and throwaway type glass fiber filter.

Water connections between chassis and the cabinet shall be accomplished via a hose kit with a stainless-steel braid. Hose kit shall have brass fittings with stainless-steel ferrules. Hose ends shall be solid External NPT which connects to mating fitting on cabinet shut off ball valve(s), and Internal NPSM (National Pipe Straight Mechanical) swivel end with fiber or EPDM washer which connects to mating threaded end connection on chassis. The hose kit shall be rated for 350 psi (2068 kPa) design working pressure.

Valve Package:

All chassis will have a factory installed valve package. The valve package consists of 2- 2 way motorized valves: 1- normally open for heating and 1- normally closed for cooling and 1- auto flow valve.

Refrigerant Circuit:

All units shall contain an HFC 410A sealed refrigerant circuit including a high efficiency scroll or rotary compressor designed for heat pump operation, an enhanced corrugated aluminum lanced fin and rifled copper tube refrigerant-to-air heat exchanger, reversing valve, coaxial (tube in tube) refrigerant-to-water heat exchanger, and safety controls including a high pressure switch, low pressure switch (loss of charge), water coil low temperature sensor, and air coil low temperature sensor. Access fittings shall be factory installed on high and low pressure refrigerant lines to facilitate field service. Activation of any safety device shall prevent compressor operation via a microprocessor lockout circuit.

Hermetic compressors shall be internally sprung and externally isolated. The compressor shall have an external, dual level vibration isolation system. The compressor will be mounted on rubber grommets to a large heavy gauge compressor mounting tray plate, which is then isolated from the cabinet base with vibration isolators for maximized vibration attenuation. Compressor shall have thermal overload protection.

Refrigerant-to-air heat exchanger shall utilize enhanced corrugated lanced aluminum fins and rifled copper tube construction. Refrigerant-to-water heat exchangers shall be of copper inner water tube and steel refrigerant outer tube design. The refrigerant-to-water heat exchanger shall be “electro-coated” with a low cure cathodic epoxy material a minimum of 0.4 mils thick (0.4 – 1.5 mils range) on all surfaces.

Cabinet Drain Pan:

The drain pan shall be constructed of galvanized steel and have a powder coat paint application to further inhibit corrosion. This corrosion protection system shall meet the stringent 1000 hour salt spray test per ASTM B117. Drain pan shall have at a minimum a doubled sloped surface to allow positive drainage to the outlet opening, which shall be at the lowest level of the entire pan surface. Drain outlet shall be connected from pan outlet to condensate riser with factory installed P-trap hose inside the cabinet. The unit as standard will be supplied with solid-state electronic condensate overflow protection.

Electrical:

A control box shall be located on the chassis and shall contain a transformer, 24 volt activated compressor relay, terminal block for thermostat wiring and solid-state controller for unit operation. Reversing valve and fan motor wiring shall be routed through this electronic controller. Units shall be name-plated for use with time delay fuses or HACR circuit breakers. Unit controls shall be 24 Volts and provide heating or cooling as required by the remote thermostat / sensor.

Solid State Control System:

Units shall have a solid-state control system. The control system shall interface with a heat pump type thermostat. The control system shall have the following features:

- a. Anti-short cycle time delay on compressor operation.
- b. Random start on power up mode.
- c. Low voltage protection.
- d. High voltage protection.
- e. Unit shutdown on high or low refrigerant pressures.
- f. Unit shutdown on low water temperature.
- g. Condensate overflow electronic protection.
- h. Automatic intelligent reset. Unit shall automatically reset 5 minutes after trip if the fault has cleared. If a fault occurs 3 times sequentially without thermostat meeting temperature, then lockout requiring manual reset will occur.
- i. Ability to disable time delays for servicing.
- j. Light emitting diodes (LEDs) on circuit board to indicate high pressure, low pressure, low voltage, high voltage, low water/air temperature cut-out, condensate overflow, and control voltage status.
- k. The low-pressure switch shall not be monitored for the first 120 seconds after a compressor start command to prevent nuisance safety trips.
- l. 24V output to cycle a motorized water valve or other device with compressor contactor.
- m. Water coil low temperature sensing (selectable for water or anti-freeze).
- n. Air coil low temperature sensing.

Supply Grilles:

Supply grille(s) shall be architecturally designed “brushed” aluminum or powder coated steel.

Front/Return panel:

The return panel shall be architecturally designed, acoustic type, flush mounted panel with hinged door for easy and quick access to filter and unit interior. Chassis shall be easily removable without removing return panel. The hinged return panel shall be made of heavy gage die formed galvanized steel with a powder coat finish.

Warranty:

Ice Air shall warranty equipment for a period of 12 months from start up. Standard warranty covers replacement of defective parts, with optional warranty add-ons for labor coverage and extended warranty periods.

FIELD INSTALLED OPTIONS**Hose Kits (required for field water connections):**

Water connections between chassis and the cabinet shall be accomplished via a hose kit surrounded by a stainless-steel braid. Hose kit shall have brass fittings with stainless-steel ferrules. Hose ends shall be solid External NPT which connects to mating fitting on the shut off ball valve(s), and Internal NPSM (National Pipe Straight Mechanical) swivel end with fiber or EPDM washer which connects to mating threaded end connection on chassis. This dual hose kit accessory is required for each cabinet.

Thermostats:

The thermostat shall be a Ice Air mechanical or electronic type thermostat as selected below with the described features:

Single Stage Auto Changeover Programmable 7 or 5/2 Day

Thermostat shall be 7 or 5 day/2 day programmable (with up to 4 set points per day), single stage (2H/2C), manual changeover with HEAT-OFF-COOL system settings and fan ON-AUTO settings. Thermostat shall have an LCD display with temperature, set-point(s), mode, and status indication. The temperature indication shall be selectable for °F or °C. The thermostat shall provide permanent memory of set-point(s) without batteries. Thermostat shall provide convenient override feature to temporarily change set point.